

Pignoni e corone ASA

ASA Sprockets and platewheels

ASA Kettenraeder und Kettenradscheiben

Pignons et disques ASA

Piñones y coronas ASA



A richiesta possiamo eseguire dentature e passi nei profili ASA non indicati nel presente Catalogo in base a consuntivo.

On request, we can carry out toothing pitch on "ASA" profiles, not indicated in this catalogue, according to estimates.

Auf Wunsch können wir Zahnungen und Teilungen in den "ASA" Profilen ausführen, die in diesem Katalog nicht angegeben sind Preis nach Kostenvoranschlag.

Possibilit  d'executer sur demande des dentures et des pas dans les profils "ASA" non indiqu s dans le catalogue, sur devis.

Previa solicitud y en base a presupuesto podemos fabricar dentados y pasos con perfiles "ASA" no se alados en el presente cat logo.

Pignoni per catene semplici, doppie e triple a rulli secondo:

DIN 8188 - ISO/R 606 - ANSI B 29,1

Sprockets for simplex, duplex and triplex chain to: DIN 8188 - ISO/R 606 - ANSI B 29,1

Kettenräder mit einseitiger Nabe für Simplex-Duplex-Triplex-Rollenkette nach:

DIN 8188 - ISO/R 606 - ANSI B 29,1

Pignons avec moyeu déporté pour chaînes simples, doubles, et triples à rouleaux suivant les normes:

DIN 8188 - ISO/R 606 - ANSI B 29,1

Piñones para cadena simple, doble y triple de rodillos según las normas:

DIN 8188 - ISO/R 606 - ANSI B 29,1

3/8" x 3/16"

ASA 35 - 1-2-3 9,525 x 4,77 mm

CATENA:	CHAIN:	KETTE:	CHAÎNE:	CADENA:	ASA 35
Passo	Pitch	Teilung	Pas	Paso	9,525
Larghezza interna	Internal width	Innere Breite	Largeur interieure	Ancho interno	4,77
Rullo ø	Roller ø	Rollen ø	ø du rouleau	Rodillo ø	5,08

PIGNONE	SPROCKETS	KETTENRÄDER	PIGNONS	PIÑONES	ASA 35
Raggio dente r	Tooth radius r	Radius r	Rayon de denture r	Radio diente r	r 10
Larghezza raggio C	Radius width C	Breite C	Largeur de rayon C	Ancho radio C	C 1,2
Largh. dente h ₁	Tooth width h ₁	Zahnbreite h ₁	Larg. de denture h ₁	Ancho diente h ₁	h₁ 4.4
Largh. dente L	Tooth width L	Zahnbreite L	Larg. de denture L	Ancho diente L	L 4.3
Largh. dente h ₂	Tooth width h ₂	Zahnbreite h ₂	Larg. de denture h ₂	Ancho diente h ₂	h₂ 14.4
Largh. dente h ₃	Tooth width h ₃	Zahnbreite h ₃	Larg. de denture h ₃	Ancho diente h ₃	h₃ 24.5
Altezza totale H	Full height H	Gesamt Höhe H	Hauteur totale H	Altura total H	H -

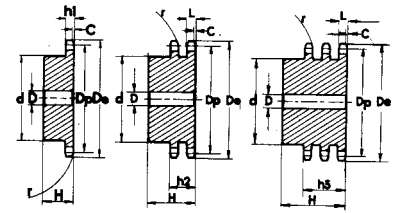

Materiale C 43 - Material C 43 - Matière C 43 - Materiel C 43 UNI 7847

Z	D _e	D _p	PS			PD				
			cod.	d	D	H	cod.	d		
10	35.70	30.82	PS 05A10	20	8	22				
11	38.69	33.80	PS 05A11	22	8	25				
12	41.68	36.80	PS 05A12	25	8	25				
13	44.68	39.80	PS 05A13	28	10	25	PD 05A13	28	10	25
14	47.68	42.80	PS 05A14	31	10	25	PD 05A14	31	10	25
15	50.69	45.81	PS 05A15	34	10	25	PD 05A15	34	10	25
16	53.70	48.82	PS 05A16	38	10	28	PD 05A16	37	12	30
17	56.72	51.83	PS 05A17	38	10	28	PD 05A17	40	12	30
18	59.73	54.85	PS 05A18	38	10	28	PD 05A18	43	12	30
19	62.75	57.87	PS 05A19	46	10	28	PD 05A19	46	12	30
20	65.77	60.89	PS 05A20	46	10	28	PD 05A20	49	12	30
21	68.79	63.91	PS 05A21	46	10	28	PD 05A21	52	16	30
22	71.81	66.93	PS 05A22	52	12	28	PD 05A22	55	16	30
23	74.83	69.95	PS 05A23	52	12	28	PD 05A23	58	16	30
24	77.85	72.97	PS 05A24	52	12	28	PD 05A24	61	16	30
25	80.88	76.00	PS 05A25	58	12	28	PD 05A25	64	16	30
26	83.90	79.02	PS 05A26	58	12	28	PD 05A26	67	16	30
27	86.93	82.04	PS 05A27	58	12	28	PD 05A27	70	16	30
28	89.95	85.07	PS 05A28	60	12	28	PD 05A28	73	16	30
30	96.00	91.12	PS 05A30	60	12	28				

PIGNONI / SPROCKETS / KETTENRÄDER / PIGNONS / PIÑONES



Pignoni per catene semplici, doppie e triple a rulli secondo:

DIN 8188 - ISO/R 606 - ANSI B 29,1

Sprockets for simplex, duplex and triplex chain to: DIN 8188 - ISO/R 606 - ANSI B 29,1

Kettenräder mit einseitiger Nabe für Simplex-Duplex-Triplex-Rollenkette nach:

DIN 8188 - ISO/R 606 - ANSI B 29,1

Pignons avec moyeu déporté pour chaînes simples, doubles, et triples à rouleaux suivant les normes:

DIN 8188 - ISO/R 606 - ANSI B 29,1

Piñones para cadena simple, doble y triple de rodillos según las normas:

DIN 8188 - ISO/R 606 - ANSI B 29,1

1/2" x 5/16"

ASA 40 - 1-2-3 12,7 x 7,94 mm

CATENA:	CHAIN:	KETTE:	CHAÎNE:	CADENA:	ASA 40
Passo	Pitch	Teilung	Pas	Paso	12,7
Larghezza interna	Internal width	Innere Breite	Largeur interieure	Ancho interno	7,94
Rullo ø	Roller ø	Rollen ø	ø du rouleau	Rodillo ø	7,94

PIGNONE	SPROCKETS	KETTENRÄDER	PIGNONS	PIÑONES	ASA 40
Raggio dente r	Tooth radius r	Radius r	Rayon de denture r	Radio diente r	r 13,5
Larghezza raggio C	Radius width C	Breite C	Largeur de rayon C	Ancho radio C	C 1,6
Largh. dente h ₁	Tooth width h ₁	Zahnbreite h ₁	Larg. de denture h ₁	Ancho diente h ₁	h ₁ 7,4
Largh. dente L	Tooth width L	Zahnbreite L	Larg. de denture L	Ancho diente L	L 7,2
Largh. dente h ₂	Tooth width h ₂	Zahnbreite h ₂	Larg. de denture h ₂	Ancho diente h ₂	h ₂ 21,6
Largh. dente h ₃	Tooth width h ₃	Zahnbreite h ₃	Larg. de denture h ₃	Ancho diente h ₃	h ₃ 36
Altezza totale H	Full height H	Gesamt Höhe H	Hauteur totale H	Altura total H	H -

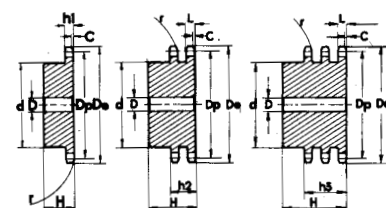
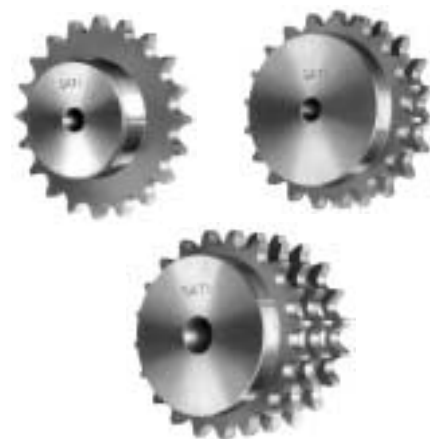

Materiale C 43 - Material C 43 - Matière C 43 - Materiel C 43 UNI 7847

Z	D _e	D _p	PS			PD			PT						
			cod.	d	D	H	cod.	d	D	H	cod.	d	D	H	
10	47.66	41.10	PS 09A10	26	10	25									
11	51.64	45.08	PS 09A11	29	10	25									
12	55.63	49.07	PS 09A12	35	10	28					PT 09A12	35	14	50	
13	59.63	53.07	PS 09A13	35	10	28	PD 09A13	38	12	35	PT 09A13	38	14	50	
14	63.63	57.07	PS 09A14	35	10	28	PD 09A14	42	12	35	PT 09A14	42	14	50	
15	67.64	61.08	PS 09A15	48	10	28	PD 09A15	46	12	35	PT 09A15	46	14	50	
16	71.66	65.10	PS 09A16	48	10	28	PD 09A16	50	14	35	PT 09A16	50	16	50	
17	75.68	69.12	PS 09A17	48	10	28	PD 09A17	54	14	35	PT 09A17	54	16	50	
18	79.70	73.14	PS 09A18	60	12	28	PD 09A18	58	14	35	PT 09A18	58	16	50	
19	83.72	77.16	PS 09A19	60	12	28	PD 09A19	62	14	35	PT 09A19	62	16	50	
20	87.74	81.18	PS 09A20	60	12	28	PD 09A20	66	14	35	PT 09A20	66	16	50	
21	91.77	85.21	PS 09A21	65	12	28	PD 09A21	70	16	40	PT 09A21	70	20	55	
22	95.80	89.24	PS 09A22	65	12	28	PD 09A22	70	16	40	PT 09A22	70	20	55	
23	99.83	93.27	PS 09A23	65	12	28	PD 09A23	70	16	40	PT 09A23	70	20	55	
24	103.86	97.30	PS 09A24	70	14	28	PD 09A24	75	16	40	PT 09A24	75	20	55	
25	107.89	101.33	PS 09A25	70	14	28	PD 09A25	80	16	40	PT 09A25	80	20	55	
26	111.92	105.36	PS 09A26	70	14	28	PD 09A26	85	20	40	PT 09A26	85	20	55	
27	115.96	109.40	PS 09A27	70	16	30	PD 09A27	85	20	40	PT 09A27	85	20	55	
28	119.99	113.43	PS 09A28	70	16	30	PD 09A28	90	20	40	PT 09A28	90	20	55	
30	128.06	121.50	PS 09A30	80	16	30	PD 09A30	100	20	40					
32	136.13	129.57	PS 09A32	80	16	30									
35	148.24	141.68	PS 09A35	90	16	30									
36	152.28	145.72	PS 09A36	90	16	30									
38	160.35	153.79	PS 09A38	90	16	35									
40	168.43	161.87	PS 09A40	90	16	35									

Pignoni per catene semplici, doppie e triple a rulli secondo:

DIN 8188 - ISO/R 606 - ANSI B 29,1

Sprockets for simplex, duplex and triplex chain to: DIN 8188 - ISO/R 606 - ANSI B 29,1

Kettenräder mit einseitiger Nabe für Simplex-Duplex-Triplex-Rollenkette nach:

DIN 8188 - ISO/R 606 - ANSI B 29,1

Pignons avec moyeu déporté pour chaînes simples, doubles, et triples à rouleaux suivant les normes:

DIN 8188 - ISO/R 606 - ANSI B 29,1

Piñones para cadena simple, doble y triple de rodillos según las normas:

DIN 8188 - ISO/R 606 - ANSI B 29,1

5/8" x 3/8"

ASA 50 - 1-2-3 15,875 x 9,52 mm

CATENA:	CHAIN:	KETTE:	CHAÎNE:	CADENA:	ASA 50
Passo	Pitch	Teilung	Pas	Paso	15,875
Larghezza interna	Internal width	Innere Breite	Largeur interieure	Ancho interno	9,52
Rullo ø	Roller ø	Rollen ø	ø du rouleau	Rodillo ø	10,16

PIGNONE	SPROCKETS	KETTENRÄDER	PIGNONS	PIÑONES	ASA 50
Raggio dente r	Tooth radius r	Radius r	Rayon de denture r	Radio diente r	r 17
Larghezza raggio C	Radius width C	Breite C	Largeur de rayon C	Ancho radio C	C 2
Largh. dente h ₁	Tooth width h ₁	Zahnbreite h ₁	Larg. de denture h ₁	Ancho diente h ₁	h ₁ 9
Largh. dente L	Tooth width L	Zahnbreite L	Larg. de denture L	Ancho diente L	L 8,8
Largh. dente h ₂	Tooth width h ₂	Zahnbreite h ₂	Larg. de denture h ₂	Ancho diente h ₂	h ₂ 26,9
Largh. dente h ₃	Tooth width h ₃	Zahnbreite h ₃	Larg. de denture h ₃	Ancho diente h ₃	h ₃ 45
Altezza totale H	Full height H	Gesamt Höhe H	Hauteur totale H	Altura total H	H -

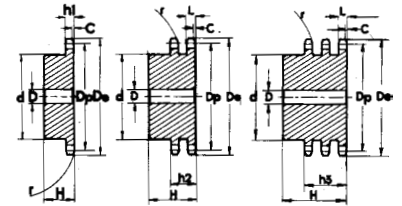

Materiale C 43 - Material C 43 - Matière C 43 - Materiel C 43 UNI 7847

Z	D _e	D _p	PS				PD				PT					
			cod.	d	D	H	cod.	d	D	H	cod.	d	D	H		
8	47,0	41,48	PS 10A08	25	10	25										
9	52,6	46,42	PS 10A09	30	10	25										
10	57,5	51,37	PS 10A10	35	10	25										
11	63,0	56,34	PS 10A11	37	12	30										
12	68,0	61,34	PS 10A12	42	12	30					PT 10A12	44	16	55		
13	73,0	66,32	PS 10A13	47	12	30	PD 10A13	49	14	40	PT 10A13	49	16	55		
14	78,0	71,34	PS 10A14	52	12	30	PD 10A14	54	14	40	PT 10A14	54	16	55		
15	83,0	76,36	PS 10A15	57	12	30	PD 10A15	59	14	40	PT 10A15	59	16	55		
16	88,0	81,37	PS 10A16	60	12	30	PD 10A16	64	16	45	PT 10A16	64	16	60		
17	93,0	86,39	PS 10A17	60	12	30	PD 10A17	69	16	45	PT 10A17	69	16	60		
18	98,3	91,42	PS 10A18	70	14	30	PD 10A18	74	16	45	PT 10A18	74	16	60		
19	103,3	96,45	PS 10A19	70	14	30	PD 10A19	79	16	45	PT 10A19	79	16	60		
20	108,4	101,49	PS 10A20	75	14	30	PD 10A20	84	16	45	PT 10A20	84	16	60		
21	113,4	106,52	PS 10A21	75	16	30	PD 10A21	85	16	45	PT 10A21	85	20	60		
22	118,0	111,55	PS 10A22	80	16	30	PD 10A22	90	16	45	PT 10A22	90	20	60		
23	123,4	116,58	PS 10A23	80	16	30	PD 10A23	95	16	45	PT 10A23	95	20	60		
24	128,3	121,62	PS 10A24	80	16	30	PD 10A24	100	16	45	PT 10A24	100	20	60		
25	134,4	126,66	PS 10A25	80	16	30	PD 10A25	105	16	45	PT 10A25	105	20	60		
26	139,0	131,70	PS 10A26	85	20	35					PT 10A26	110	20	60		
27	144,0	136,75	PS 10A27	85	20	35					PT 10A27	110	20	60		
28	148,7	141,78	PS 10A28	90	20	35					PT 10A28	115	20	60		
29	153,8	146,83	PS 10A29	90	20	35										
30	158,8	151,87	PS 10A30	90	20	35										
31	163,9	156,92	PS 10A31	95	20	35										
32	168,9	161,95	PS 10A32	95	20	35										
33	174,5	167,00	PS 10A33	95	20	35										
34	179,0	172,05	PS 10A34	95	20	35										
35	184,1	177,10	PS 10A35	95	20	35										
36	189,1	182,15	PS 10A36	100	20	35										
37	194,2	187,20	PS 10A37	100	20	35										
38	199,2	192,24	PS 10A38	100	20	35										
39	204,2	197,29	PS 10A39	100	20	35										
40	209,3	202,34	PS 10A40	100	20	35										

PIGNONI / SPROCKETS / KETTENRÄDER / PIGNONS / PIÑONES



Pignoni per catene semplici, doppie e triple a rulli secondo:

DIN 8188 - ISO/R 606 - ANSI B 29,1

Sprockets for simplex, duplex and triplex chain to: DIN 8188 - ISO/R 606 - ANSI B 29,1

Kettenräder mit einseitiger Nabe für Simplex-Duplex-Triplex-Rollenkette nach:

DIN 8188 - ISO/R 606 - ANSI B 29,1

Pignons avec moyeu déporté pour chaînes simples, doubles, et triples à rouleaux suivant les normes:

DIN 8188 - ISO/R 606 - ANSI B 29,1

Piñones para cadena simple, doble y triple de rodillos según las normas:

DIN 8188 - ISO/R 606 - ANSI B 29,1

3/4" x 1/2"

ASA 60 - 1-2-3 19,05 x 12,7 mm

CATENA:	CHAIN:	KETTE:	CHAÎNE:	CADENA:	ASA 60
Passo	Pitch	Teilung	Pas	Paso	19,05
Larghezza interna	Internal width	Innere Breite	Largeur interieure	Ancho interno	12,7
Rullo ø	Roller ø	Rollen ø	ø du rouleau	Rodillo ø	11,91

PIGNONE	SPROCKETS	KETTENRÄDER	PIGNONS	PIÑONES	ASA 60
Raggio dente r	Tooth radius r	Radius r	Rayon de denture r	Radio diente r	r 20
Larghezza raggio C	Radius width C	Breite C	Largeur de rayon C	Ancho radio C	C 2,4
Largh. dente h ₁	Tooth width h ₁	Zahnbreite h ₁	Larg. de denture h ₁	Ancho diente h ₁	h ₁ 12
Largh. dente L	Tooth width L	Zahnbreite L	Larg. de denture L	Ancho diente L	L 11,8
Largh. dente h ₂	Tooth width h ₂	Zahnbreite h ₂	Larg. de denture h ₂	Ancho diente h ₂	h ₂ 34,6
Largh. dente h ₃	Tooth width h ₃	Zahnbreite h ₃	Larg. de denture h ₃	Ancho diente h ₃	h ₃ 57,4
Altezza totale H	Full height H	Gesamt Höhe H	Hauteur totale H	Altura total H	H -

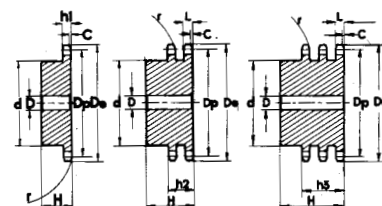
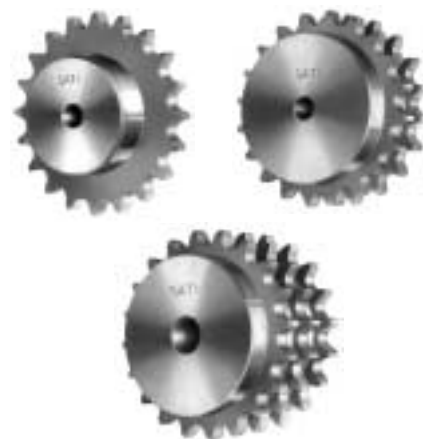

Materiale C 43 - Material C 43 - Matière C 43 - Materiel C 43 UNI 7847

Z	D _e	D _p	PS			PD			PT					
			cod.	d	D	H	cod.	d	D	H	cod.	d	D	H
10	71,54	61,64	PS 11A10	42	12	30	PD 11A10	42	12	45				
11	77,51	67,61	PS 11A11	45	12	30	PD 11A11	47	16	50				
12	83,49	73,61	PS 11A12	45	12	30	PD 11A12	53	16	50	PT 11A12	53	20	70
13	89,49	79,59	PS 11A13	60	14	35	PD 11A13	59	16	50	PT 11A13	59	20	70
14	95,50	85,61	PS 11A14	60	14	35	PD 11A14	65	16	50	PT 11A14	65	20	70
15	101,52	91,63	PS 11A15	60	14	35	PD 11A15	71	16	50	PT 11A15	71	20	70
16	107,54	97,65	PS 11A16	75	16	35	PD 11A16	77	20	50	PT 11A16	77	20	70
17	113,56	103,67	PS 11A17	75	16	35	PD 11A17	83	20	50	PT 11A17	83	20	70
18	119,59	109,71	PS 11A18	75	16	35	PD 11A18	89	20	50	PT 11A18	89	20	70
19	125,63	115,75	PS 11A19	80	16	35	PD 11A19	95	20	50	PT 11A19	95	20	70
20	131,67	121,78	PS 11A20	80	16	35	PD 11A20	100	20	50	PT 11A20	100	20	70
21	137,71	127,82	PS 11A21	80	16	35	PD 11A21	100	20	50	PT 11A21	100	20	70
22	143,75	133,86	PS 11A22	90	20	40	PD 11A22	100	20	50	PT 11A22	100	20	70
23	149,79	139,90	PS 11A23	90	20	40	PD 11A23	110	20	50	PT 11A23	110	20	70
24	155,84	145,94	PS 11A24	90	20	40	PD 11A24	110	20	50	PT 11A24	110	20	70
25	161,88	152,00	PS 11A25	90	20	40	PD 11A25	120	20	50	PT 11A25	120	20	70
26	167,93	158,04	PS 11A26	90	20	40	PD 11A26	120	20	50				
27	173,98	164,09	PS 11A27	90	20	40	PD 11A27	120	20	50				
28	180,03	170,13	PS 11A28	95	20	40	PD 11A28	120	20	50				
30	192,14	182,25	PS 11A30	95	20	40	PD 11A30	120	20	50				

Pignoni per catene semplici, doppie e triple a rulli secondo:

DIN 8188 - ISO/R 606 - ANSI B 29,1

Sprockets for simplex, duplex and triplex chain to: DIN 8188 - ISO/R 606 - ANSI B 29,1

Kettenräder mit einseitiger Nabe für Simplex-Duplex-Triplex-Rollenkette nach:

DIN 8188 - ISO/R 606 - ANSI B 29,1

Pignons avec moyeu déporté pour chaînes simples, doubles, et triples à rouleaux suivant les normes:

DIN 8188 - ISO/R 606 - ANSI B 29,1

Piñones para cadena simple, doble y triple de rodillos según las normas:

DIN 8188 - ISO/R 606 - ANSI B 29,1

1" x 5/8"

ASA 80 - 1-2-3 25,4 x 15,88 mm

CATENA:	CHAIN:	KETTE:	CHAÎNE:	CADENA:	ASA 80
Passo	Pitch	Teilung	Pas	Paso	25,4
Larghezza interna	Internal width	Innere Breite	Largeur interieure	Ancho interno	15,88
Rullo ø	Roller ø	Rollen ø	ø du rouleau	Rodillo ø	15,88

PIGNONE	SPROCKETS	KETTENRÄDER	PIGNONS	PIÑONES	ASA 80
Raggio dente r	Tooth radius r	Radius r	Rayon de denture r	Radio diente r	r 27
Larghezza raggio C	Radius width C	Breite C	Largeur de rayon C	Ancho radio C	C 3,2
Largh. dente h ₁	Tooth width h ₁	Zahnbreite h ₁	Larg. de denture h ₁	Ancho diente h ₁	h ₁ 15
Largh. dente L	Tooth width L	Zahnbreite L	Larg. de denture L	Ancho diente L	L 14,7
Largh. dente h ₂	Tooth width h ₂	Zahnbreite h ₂	Larg. de denture h ₂	Ancho diente h ₂	h ₂ 44,0
Largh. dente h ₃	Tooth width h ₃	Zahnbreite h ₃	Larg. de denture h ₃	Ancho diente h ₃	h ₃ 73,3
Altezza totale H	Full height H	Gesamt Höhe H	Hauteur totale H	Altura total H	H -

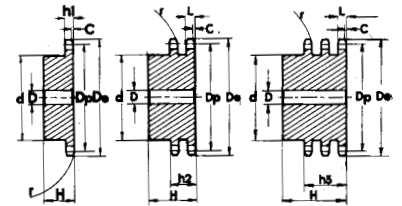

Materiale C 43 - Material C 43 - Matière C 43 - Materiel C 43 UNI 7847

Z	D _e	D _p	PS				PD				PT				
			cod.	d	D	H	cod.	d	D	H	cod.	d	D	H	
8	79,49	66,37	PS 12A08	42	16	35									
9	87,38	74,27	PS 12A09	50	16	35									
10	95,32	82,19	PS 12A10	55	16	35									
11	103,28	90,14	PS 12A11	61	16	40									
12	111,26	98,14	PS 12A12	69	16	40	PD 12A12	72	20	70	PT 12A12	72	25	100	
13	119,26	106,12	PS 12A13	78	16	40	PD 12A13	80	20	70	PT 12A13	80	25	100	
14	127,27	114,15	PS 12A14	84	16	40	PD 12A14	88	20	70	PT 12A14	88	25	100	
15	135,29	122,17	PS 12A15	92	16	40	PD 12A15	96	20	70	PT 12A15	96	25	100	
16	143,32	130,20	PS 12A16	100	20	45	PD 12A16	104	20	70	PT 12A16	104	30	100	
17	151,35	138,22	PS 12A17	100	20	45	PD 12A17	112	20	70	PT 12A17	112	30	100	
18	159,39	146,28	PS 12A18	100	20	45	PD 12A18	120	20	70	PT 12A18	120	30	100	
19	167,44	154,33	PS 12A19	100	20	45	PD 12A19	128	20	70	PT 12A19	128	30	100	
20	175,49	162,38	PS 12A20	100	20	45	PD 12A20	130	20	70	PT 12A20	130	30	100	
21	183,54	170,43	PS 12A21	110	20	50	PD 12A21	130	25	70					
22	191,60	178,48	PS 12A22	110	20	50									
23	199,66	186,53	PS 12A23	110	20	50									
24	207,72	194,59	PS 12A24	110	20	50									
25	215,78	202,66	PS 12A25	110	20	50									
26	223,84	210,72	PS 12A26	120	20	50									
27	231,91	218,79	PS 12A27	120	20	50									
28	239,98	226,85	PS 12A28	120	20	50									
29	248,05	234,92	PS 12A29	120	20	50									
30	256,12	243,00	PS 12A30	120	20	50									

PIGNONI / SPROCKETS / KETTENRÄDER / PIGNONS / PIÑONES



Pignoni per catene semplici, doppie e triple a rulli secondo:

DIN 8188 - ISO/R 606 - ANSI B 29,1

Sprockets for simplex, duplex and triplex chain to: DIN 8188 - ISO/R 606 - ANSI B 29,1

Kettenräder mit einseitiger Nabe für Simplex-Duplex-Triplex-Rollenkette nach:

DIN 8188 - ISO/R 606 - ANSI B 29,1

Pignons avec moyeu déporté pour chaînes simples, doubles, et triples à rouleaux suivant les normes:

DIN 8188 - ISO/R 606 - ANSI B 29,1

Piñones para cadena simple, doble y triple de rodillos según las normas:

DIN 8188 - ISO/R 606 - ANSI B 29,1

1"1/4 x 3/4"

ASA 100 - 1-2-3 31,75 x 19,05 mm

CATENA:	CHAIN:	KETTE:	CHAÎNE:	CADENA:	ASA 100
Passo	Pitch	Teilung	Pas	Paso	31,75
Larghezza interna	Internal width	Innere Breite	Largeur interieure	Ancho interno	19,05
Rullo ø	Roller ø	Rollen ø	ø du rouleau	Rodillo ø	19,05

PIGNONE	SPROCKETS	KETTENRÄDER	PIGNONS	PIÑONES	ASA 100
Raggio dente r	Tooth radius r	Radius r	Rayon de denture r	Radio diente r	r 33,5
Larghezza raggio C	Radius width C	Breite C	Largeur de rayon C	Ancho radio C	C 4
Largh. dente h ₁	Tooth width h ₁	Zahnbreite h ₁	Larg. de denture h ₁	Ancho diente h ₁	h ₁ 18
Largh. dente L	Tooth width L	Zahnbreite L	Larg. de denture L	Ancho diente L	L 17,7
Largh. dente h ₂	Tooth width h ₂	Zahnbreite h ₂	Larg. de denture h ₂	Ancho diente h ₂	h ₂ 53,5
Largh. dente h ₃	Tooth width h ₃	Zahnbreite h ₃	Larg. de denture h ₃	Ancho diente h ₃	h ₃ 89,2
Altezza totale H	Full height H	Gesamt Höhe H	Hauteur totale H	Altura total H	H -

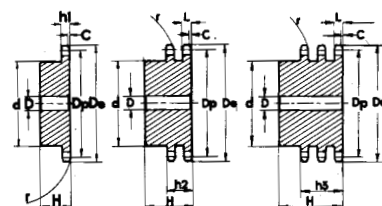
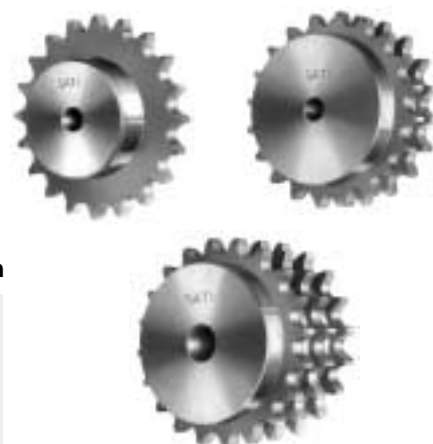

Materiale C 43 - Material C 43 - Matière C 43 - Materiel C 43 UNI 7847

Z	D _e	D _p	PS				PD				PT					
			cod.	d	D	H	cod.	d	D	H	cod.	d	D	H		
8	98,1	82,96	PS 13A08	53	20	40										
9	108,0	92,84	PS 13A09	63	20	40										
10	117,9	102,74	PS 13A10	70	20	40										
11	127,8	112,68	PS 13A11	77	20	45										
12	137,8	122,68	PS 13A12	88	20	45	PD 13A12	90	20	80						
13	147,8	132,65	PS 13A13	98	20	45	PD 13A13	100	20	80						
14	157,8	142,68	PS 13A14	108	20	45	PD 13A14	110	20	80						
15	167,9	152,72	PS 13A15	118	20	45	PD 13A15	120	20	80						
16	177,9	162,75	PS 13A16	120	25	50	PD 13A16	120	25	80						
17	187,9	172,78	PS 13A17	120	25	50	PD 13A17	120	25	80						
18	198,0	182,85	PS 13A18	120	25	50										
19	208,1	192,91	PS 13A19	120	25	50										
20	218,1	202,98	PS 13A20	120	25	50										
21	228,2	213,04	PS 13A21	140	25	55										
22	238,3	223,11	PS 13A22	140	25	55										
23	248,3	233,17	PS 13A23	140	25	55										
24	258,4	243,23	PS 13A24	140	25	55										
25	268,5	253,33	PS 13A25	140	25	55										

Pignoni per catene semplici, doppie e triple a rulli secondo:

DIN 8188 - ISO/R 606 - ANSI B 29,1

Sprockets for simplex, duplex and triplex chain to: DIN 8188 - ISO/R 606 - ANSI B 29,1

Kettenräder mit einseitiger Nabe für Simplex-Duplex-Triplex-Rollenkette nach:

DIN 8188 - ISO/R 606 - ANSI B 29,1

Pignons avec moyeu déporté pour chaînes simples, doubles, et triples à rouleaux suivant les normes:

DIN 8188 - ISO/R 606 - ANSI B 29,1

Piñones para cadena simple, doble y triple de rodillos según las normas:

DIN 8188 - ISO/R 606 - ANSI B 29,1

1"1/2 x 1"

ASA 120 - 1-2-3 38,1 x 25,4 mm

CATENA:	CHAIN:	KETTE:	CHAÎNE:	CADENA:	ASA 120
Passo	Pitch	Teilung	Pas	Paso	38,1
Larghezza interna	Internal width	Innere Breite	Largeur interieure	Ancho interno	25,4
Rullo ø	Roller ø	Rollen ø	ø du rouleau	Rodillo ø	22,22

PIGNONE	SPROCKETS	KETTENRÄDER	PIGNONS	PIÑONES	ASA 120
Raggio dente r	Tooth radius r	Radius r	Rayon de denture r	Radio diente r	r 40,5
Larghezza raggio C	Radius width C	Breite C	Largeur de rayon C	Ancho radio C	C 4,8
Largh. dente h ₁	Tooth width h ₁	Zahnbreite h ₁	Larg. de denture h ₁	Ancho diente h ₁	h ₁ 24,1
Largh. dente L	Tooth width L	Zahnbreite L	Larg. de denture L	Ancho diente L	L 23,6
Largh. dente h ₂	Tooth width h ₂	Zahnbreite h ₂	Larg. de denture h ₂	Ancho diente h ₂	h ₂ 69
Largh. dente h ₃	Tooth width h ₃	Zahnbreite h ₃	Larg. de denture h ₃	Ancho diente h ₃	h ₃ 114,5
Altezza totale H	Full height H	Gesamt Höhe H	Hauteur totale H	Altura total H	H -

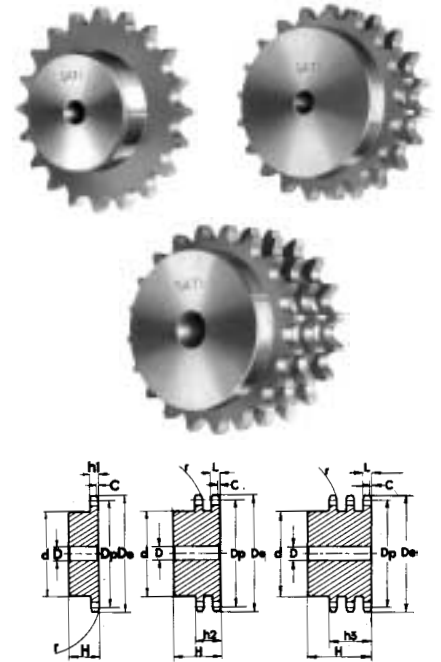

Materiale C 43 - Material C 43 - Matière C 43 - Materiel C 43 UNI 7847

Z	D _e	D _p	PS				PD				PT					
			cod.	d	D	H	cod.	d	D	H	cod.	d	D	H		
8	119,04	99,55	PS 14A08	58	20	45										
9	130,88	111,40	PS 14A09	70	20	45										
10	142,77	123,29	PS 14A10	80	20	45										
11	154,71	135,21	PS 14A11	90	25	50										
12	166,69	147,22	PS 14A12	102	25	50	PD 14A12	102	25	100						
13	178,68	159,18	PS 14A13	114	25	50	PD 14A13	114	25	100						
14	190,70	171,22	PS 14A14	128	25	50	PD 14A14	128	25	100						
15	202,73	183,26	PS 14A15	140	25	50	PD 14A15	140	25	100						

1"3/4 x 1"1/4

ASA 140 - 1-2-3 44,45 x 25,4 mm

CATENA:	CHAIN:	KETTE:	CHAÎNE:	CADENA:	ASA 140
Passo	Pitch	Teilung	Pas	Paso	44,45
Larghezza interna	Internal width	Innere Breite	Largeur interieure	Ancho interno	25,4
Rullo ø	Roller ø	Rollen ø	ø du rouleau	Rodillo ø	25,4

PIGNONE	SPROCKETS	KETTENRÄDER	PIGNONS	PIÑONES	ASA 140
Raggio dente r	Tooth radius r	Radius r	Rayon de denture r	Radio diente r	r 47,5
Larghezza raggio C	Radius width C	Breite C	Largeur de rayon C	Ancho radio C	C 5,8
Largh. dente h ₁	Tooth width h ₁	Zahnbreite h ₁	Larg. de denture h ₁	Ancho diente h ₁	h ₁ 24,1
Largh. dente L	Tooth width L	Zahnbreite L	Larg. de denture L	Ancho diente L	L 23,6
Largh. dente h ₂	Tooth width h ₂	Zahnbreite h ₂	Larg. de denture h ₂	Ancho diente h ₂	h ₂ 72,5
Largh. dente h ₃	Tooth width h ₃	Zahnbreite h ₃	Larg. de denture h ₃	Ancho diente h ₃	h ₃ 121,3
Altezza totale H	Full height H	Gesamt Höhe H	Hauteur totale H	Altura total H	H -



2" x 1"1/4

ASA 160 - 1-2-3 50,8 x 31,75 mm

CATENA:	CHAIN:	KETTE:	CHAÎNE:	CADENA:	ASA 160
Passo	Pitch	Teilung	Pas	Paso	50,8
Larghezza interna	Internal width	Innere Breite	Largeur interieure	Ancho interno	31,75
Rullo ø	Roller ø	Rollen ø	ø du rouleau	Rodillo ø	28,58

PIGNONE	SPROCKETS	KETTENRÄDER	PIGNONS	PIÑONES	ASA 160
Raggio dente r	Tooth radius r	Radius r	Rayon de denture r	Radio diente r	r 54
Larghezza raggio C	Radius width C	Breite C	Largeur de rayon C	Ancho radio C	C 7
Largh. dente h ₁	Tooth width h ₁	Zahnbreite h ₁	Larg. de denture h ₁	Ancho diente h ₁	h ₁ 30,1
Largh. dente L	Tooth width L	Zahnbreite L	Larg. de denture L	Ancho diente L	L 29,5
Largh. dente h ₂	Tooth width h ₂	Zahnbreite h ₂	Larg. de denture h ₂	Ancho diente h ₂	h ₂ 88
Largh. dente h ₃	Tooth width h ₃	Zahnbreite h ₃	Larg. de denture h ₃	Ancho diente h ₃	h ₃ 146,6
Altezza totale H	Full height H	Gesamt Höhe H	Hauteur totale H	Altura total H	H -

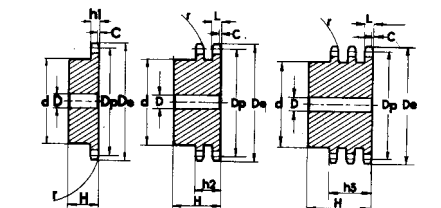

CORONE / PLATE WHEELS / KETTENRADSCHLEIBEN / DISQUES / CORONAS



Corone per catene semplici, doppie e triple a rulli secondo: DIN 8188 - ISO/R 606 - ANSI B 29,1

Plate wheels for simplex, duplex and triplex chain to: DIN 8188 - ISO/R 606 - ANSI B 29,1

Kettenradscheiben mit einseitiger Nabe für Simplex- Duplex-Triplex-Rollenkette nach:

DIN 8188 - ISO/R 606 - ANSI B 29,1

Disques avec moyeu déporté pour chaînes simples, doubles et triples à rouleaux suivant les normes:

DIN 8188 - ISO/R 606 - ANSI B 29,1

Coronas para cadena simple, doble y triple de rodillos según: DIN 8188 - ISO/R 606 - ANSI B 29,1

3/8" x 3/16"

ASA 35 - 1-2-3 9,525 x 4,77 mm

CATENA:	CHAIN:	KETTE:	CHAÎNE:	CADENA:	ASA 35
Passo	Pitch	Teilung	Pas	Paso	9,525
Larghezza interna	Internal width	Innere Breite	Largeur interieure	Ancho interno	4,77
Rullo ø	Roller ø	Rollen ø	ø du rouleau	Rodillo ø	5,08

CORONE	PLATE WHEELS	KETTENRÄDSCHLEIBEN	DISQUES	CORONAS	ASA 35
Raggio dente r	Tooth radius r	Radius r	Rayon de denture r	Radio diente r	r 10
Larghezza raggio C	Radius width C	Breite C	Largeur de rayon C	Ancho radio C	C 1,2
Largh. dente h ₁	Tooth width h ₁	Zahnbreite h ₁	Larg. de denture h ₁	Ancho diente h ₁	h ₁ 4,4
Largh. dente L	Tooth width L	Zahnbreite L	Larg. de denture L	Ancho diente L	L 4,3
Largh. dente h ₂	Tooth width h ₂	Zahnbreite h ₂	Larg. de denture h ₂	Ancho diente h ₂	h ₂ 14,4
Largh. dente h ₃	Tooth width h ₃	Zahnbreite h ₃	Larg. de denture h ₃	Ancho diente h ₃	h ₃ 24,5
Altezza totale H	Full height H	Gesamt Höhe H	Hauteur totale H	Altura total H	H -

Z	D _e	D _p	CS		CD	
			cod.	D	cod.	D
30	96,00	91,12			CD 05A30	12
32	102,06	97,17	CS 05A32	12		
36	114,17	109,29	CS 05A36	12		
38	120,22	115,34	CS 05A38	12	CD 05A38	14
40	126,28	121,40	CS 05A40	12		
45	141,43	136,55	CS 05A45	16	CD 05A45	16
48	150,52	145,64	CS 05A48	16		
57	177,79	172,91	CS 05A57	16	CD 05A57	16
76	235,37	230,49	CS 05A76	20	CD 05A76	20

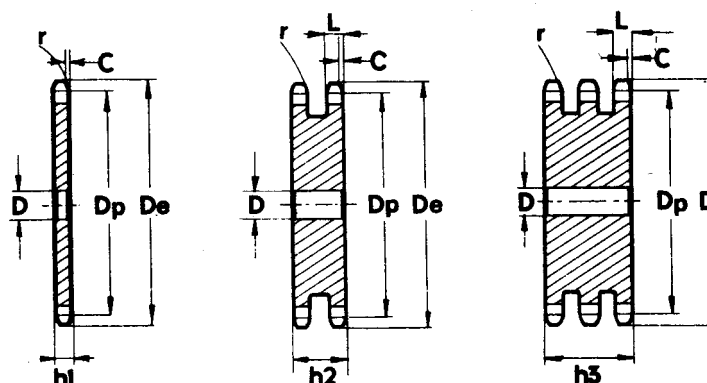

1/2" x 5/16"

ASA 40 - 1-2-3 12,7 x 7,94 mm

CATENA:	CHAIN:	KETTE:	CHAÎNE:	CADENA:	ASA 40
Passo	Pitch	Teilung	Pas	Paso	12,7
Larghezza interna	Internal width	Innere Breite	Largeur interieure	Ancho interno	7,94
Rullo ø	Roller ø	Rollen ø	ø du rouleau	Rodillo ø	7,94

CORONE	PLATE WHEELS	KETTENRÄDSCHLEIBEN	DISQUES	CORONAS	ASA 40
Raggio dente r	Tooth radius r	Radius r	Rayon de denture r	Radio diente r	r 13,5
Larghezza raggio C	Radius width C	Breite C	Largeur de rayon C	Ancho radio C	C 1,6
Largh. dente h ₁	Tooth width h ₁	Zahnbreite h ₁	Larg. de denture h ₁	Ancho diente h ₁	h ₁ 7,4
Largh. dente L	Tooth width L	Zahnbreite L	Larg. de denture L	Ancho diente L	L 7,2
Largh. dente h ₂	Tooth width h ₂	Zahnbreite h ₂	Larg. de denture h ₂	Ancho diente h ₂	h ₂ 21,6
Largh. dente h ₃	Tooth width h ₃	Zahnbreite h ₃	Larg. de denture h ₃	Ancho diente h ₃	h ₃ 36
Altezza totale H	Full height H	Gesamt Höhe H	Hauteur totale H	Altura total H	H -

Z	D _e	D _p	CS		CD		CT	
			cod.	D	cod.	D	cod.	D
30	128,06	121,50					CT 09A30	20
32	136,13	129,57			CD 09A32	16		
38	160,35	153,79			CD 09A38	20	CT 09A38	25
40	168,43	161,87			CD 09A40	20		
42	176,50	169,94	CS 09A42	20				
45	188,62	182,06	CS 09A45	20	CD 09A45	20	CT 09A45	25
48	200,74	194,18	CS 09A48	20				
57	237,10	230,54	CS 09A57	20	CD 09A57	25	CT 09A57	25
76	313,88	307,32	CS 09A76	25	CD 09A76	25	CT 09A76	25
95	390,67	384,11			CD 09A95	25		

Corone tornite sui lati, dentate con creatore
Plate Wheels turned on both sides and
toothed by milling cutter
Seitlich plan gedrehte, wälzgefräste
Zahnkränze
Disques tournés sur les flancs,
dentés à la fraise
Coronas torneadas en los lados,
dientes obtenidos con fresa madre

Corone per catene semplici, doppie e triple a rulli secondo: DIN 8188 - ISO/R 606 - ANSI B 29,1

Plate wheels for simplex, duplex and triplex chain to: DIN 8188 - ISO/R 606 - ANSI B 29,1

Kettenradscheiben mit einseitiger Nabe für Simplex- Duplex-Triplex-Rollenkette nach:

DIN 8188 - ISO/R 606 - ANSI B 29,1

Disques avec moyeu déporté pour chaînes simples, doubles et triples à rouleaux suivant les normes:

DIN 8188 - ISO/R 606 - ANSI B 29,1

Coronas para cadena simple, doble y triple de rodillos según: DIN 8188 - ISO/R 606 - ANSI B 29,1

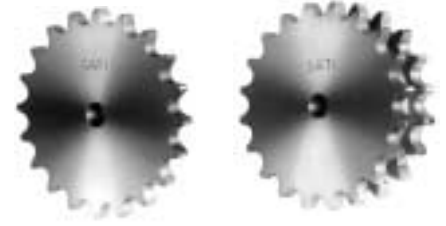

5/8" x 3/8"

ASA 50 - 1-2-3 15,875 x 9,52 mm

CATENA:	CHAIN:	KETTE:	CHAÎNE:	CADENA:	ASA 50
Passo	Pitch	Teilung	Pas	Paso	15,875
Larghezza interna	Internal width	Innere Breite	Largeur interieure	Ancho interno	9,52
Rullo ø	Roller ø	Rollen ø	ø du rouleau	Rodillo ø	10,16

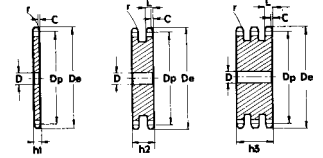

CORONE	PLATE WHEELS	KETTENRÄDSCHLEIBEN	DISQUES	CORONAS	ASA 50
Raggio dente r	Tooth radius r	Radius r	Rayon de denture r	Radio diente r	r 17
Larghezza raggio C	Radius width C	Breite C	Largeur de rayon C	Ancho radio C	C 2
Largh. dente h ₁	Tooth width h ₁	Zahnbreite h ₁	Larg. de denture h ₁	Ancho diente h ₁	h₁ 9
Largh. dente L	Tooth width L	Zahnbreite L	Larg. de denture L	Ancho diente L	L 8,8
Largh. dente h ₂	Tooth width h ₂	Zahnbreite h ₂	Larg. de denture h ₂	Ancho diente h ₂	h₂ 26,9
Largh. dente h ₃	Tooth width h ₃	Zahnbreite h ₃	Larg. de denture h ₃	Ancho diente h ₃	h₃ 45
Altezza totale H	Full height H	Gesamt Höhe H	Hauteur totale H	Altura total H	H -

Corone tornite sui lati, dentate con creatore
 Plate Wheels turned on both sides and
 toothed by milling cutter
 Seitlich plan gedrehte, wälzgefräste
 Zahnkränze
 Disques tournés sur les flancs, dentés à
 la fraise
 Coronas torneadas en los lados, dientes
 obtenidos con fresa madre

Z	D _e	D _p	CS		CD		CT		Z	D _e	D _p	CS		CD		CT	
			cod.	D	cod.	D	cod.	D				cod.	D	cod.	D	cod.	D
8	47,0	41,48	CS 10A08	10					44	230,0	222,53	CS 10A44	20				
9	52,6	46,42	CS 10A09	10					45	235,0	227,58	CS 10A45	20	CD 10A45	20	CT 10A45	25
10	57,5	51,37	CS 10A10	10					46	240,1	232,63	CS 10A46	20				
11	63,0	56,34	CS 10A11	10					47	245,1	237,68	CS 10A47	20				
12	68,0	61,34	CS 10A12	10					48	250,2	242,73	CS 10A48	20				
13	73,0	66,32	CS 10A13	10					49	255,2	247,78	CS 10A49	20				
14	78,0	71,34	CS 10A14	10					50	260,3	252,82	CS 10A50	20				
15	83,0	76,36	CS 10A15	10					51	265,3	257,87	CS 10A51	20				
16	88,0	81,37	CS 10A16	12					52	270,4	262,92	CS 10A52	20				
17	93,0	86,38	CS 10A17	12					53	275,4	267,97	CS 10A53	20				
18	98,3	91,42	CS 10A18	12					54	280,5	273,03	CS 10A54	20				
19	103,3	96,45	CS 10A19	12					55	285,5	278,08	CS 10A55	20				
20	108,4	101,49	CS 10A20	12					56	296,0	283,13	CS 10A56	25				
21	113,4	106,52	CS 10A21	12					57	290,6	288,18	CS 10A57	25	CD 10A57	25	CT 10A57	25
22	118,0	111,55	CS 10A22	12					58	300,7	293,23	CS 10A58	25				
23	123,5	116,58	CS 10A23	12					59	305,7	298,27	CS 10A59	25				
24	128,3	121,62	CS 10A24	12					60	310,8	303,32	CS 10A60	25				
25	134,0	126,66	CS 10A25	12					62	321,4	313,43	CS 10A62	25				
26	139,0	131,70	CS 10A26	16					64	331,5	321,53	CS 10A64	25				
27	144,0	136,75	CS 10A27	16					65	336,5	328,58	CS 10A65	25				
28	148,7	141,78	CS 10A28	16					66	341,6	333,63	CS 10A66	25				
29	153,8	146,83	CS 10A29	16					68	351,7	343,74	CS 10A68	25				
30	158,8	151,87	CS 10A30	16	CD 10A30	20	CT 10A30	20	70	361,8	353,84	CS 10A70	25				
31	163,9	156,92	CS 10A31	16					72	371,9	363,95	CS 10A72	25				
32	168,9	161,95	CS 10A32	16					75	387,1	379,09	CS 10A75	25				
33	174,5	167,00	CS 10A33	16					76	392,1	384,16	CS 10A76	25	CD 10A76	25	CT 10A76	30
34	179,0	172,05	CS 10A34	16					78	402,2	394,25	CS 10A78	25				
35	184,1	177,10	CS 10A35	20					80	412,3	404,35	CS 10A80	30				
36	189,1	182,15	CS 10A36	20					85	437,6	429,62	CS 10A85	30				
37	194,2	187,20	CS 10A37	20					90	462,8	454,88	CS 10A90	30				
38	199,2	192,24	CS 10A38	20	CD 10A38	20	CT 10A38	25	95	488,5	480,14	CS 10A95	30	CD 10A95	30		
39	204,2	197,29	CS 10A39	20					100	513,4	505,39	CS 1A100	30				
40	209,3	202,34	CS 10A40	20					110	563,9	555,92	CS 1A110	30				
41	214,8	207,39	CS 10A41	20					114	584,1	576,13	CS 1A114	30				
42	219,9	212,44	CS 10A42	20					120	614,4	606,45	CS 1A120	30				
43	224,9	217,49	CS 10A43	20					125	639,7	631,51	CS 1A125	30				

CORONE / PLATE WHEELS / KETTENRADSCHIEBEN / DISQUES / CORONAS



Corone per catene semplici, doppie e triple a rulli secondo: DIN 8188 - ISO/R 606 - ANSI B 29,1

Plate wheels for simplex, duplex and triplex chain to: DIN 8188 - ISO/R 606 - ANSI B 29,1

Kettenradscheiben mit einseitiger Nabe für Simplex- Duplex-Triplex-Rollenkette nach:

DIN 8188 - ISO/R 606 - ANSI B 29,1

Disques avec moyeu déporté pour chaînes simples, doubles et triples à rouleaux suivant les normes:

DIN 8188 - ISO/R 606 - ANSI B 29,1

Coronas para cadena simple, doble y triple de rodillos según: DIN 8188 - ISO/R 606 - ANSI B 29,1

3/4" x 1/2"

ASA 60 - 1-2-3 19,05 x 12,7 mm

CATENA:	CHAIN:	KETTE:	CHAÎNE:	CADENA:	ASA 60
Passo	Pitch	Teilung	Pas	Paso	19,05
Larghezza interna	Internal width	Innere Breite	Largeur interieure	Ancho interno	12,7
Rullo ø	Roller ø	Rollen ø	ø du rouleau	Rodillo ø	11,91

CORONE	PLATE WHEELS	KETTENRÄDSCHIEBEN	DISQUES	CORONAS	ASA 60
Raggio dente r	Tooth radius r	Radius r	Rayon de denture r	Radio diente r	r 20
Larghezza raggio C	Radius width C	Breite C	Largeur de rayon C	Ancho radio C	C 2,4
Largh. dente h ₁	Tooth width h ₁	Zahnbreite h ₁	Larg. de denture h ₁	Ancho diente h ₁	h ₁ 12
Largh. dente L	Tooth width L	Zahnbreite L	Larg. de denture L	Ancho diente L	L 11,8
Largh. dente h ₂	Tooth width h ₂	Zahnbreite h ₂	Larg. de denture h ₂	Ancho diente h ₂	h ₂ 34,6
Largh. dente h ₃	Tooth width h ₃	Zahnbreite h ₃	Larg. de denture h ₃	Ancho diente h ₃	h ₃ 57,4
Altezza totale H	Full height H	Gesamt Höhe H	Hauteur totale H	Altura total H	H -

Z	D _e	D _p	CS		CD		CT	
			cod.	D	cod.	D	cod.	D
30	192,14	182,25					CT 11A30	20
32	204,24	194,35			CD 11A32	20		
38	240,58	230,69	CS 11A38	20	CD 11A38	25	CT 11A38	25
40	252,69	242,80	CS 11A40	20	CD 11A40	25		
45	282,98	273,09	CS 11A45	25	CD 11A45	25	CT 11A45	25
48	301,16	291,27	CS 11A48	25				
57	355,70	345,81	CS 11A57	25	CD 11A57	25	CT 11A57	30
76	470,87	460,98	CS 11A76	25	CD 11A76	30	CT 11A76	30
95	586,06	576,17			CD 11A95	30		

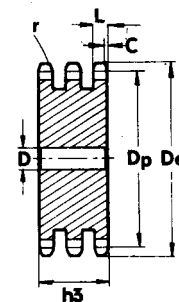
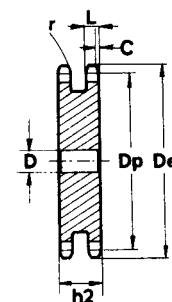
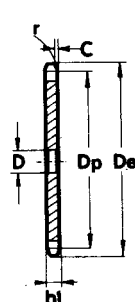

1" x 5/8"

ASA 80 - 1-2-3 25,4 x 15,88 mm

CATENA:	CHAIN:	KETTE:	CHAÎNE:	CADENA:	ASA 80
Passo	Pitch	Teilung	Pas	Paso	25,4
Larghezza interna	Internal width	Innere Breite	Largeur interieure	Ancho interno	15,88
Rullo ø	Roller ø	Rollen ø	ø du rouleau	Rodillo ø	15,88

CORONE	PLATE WHEELS	KETTENRÄDSCHIEBEN	DISQUES	CORONAS	ASA 80
Raggio dente r	Tooth radius r	Radius r	Rayon de denture r	Radio diente r	r 27
Larghezza raggio C	Radius width C	Breite C	Largeur de rayon C	Ancho radio C	C 3,2
Largh. dente h ₁	Tooth width h ₁	Zahnbreite h ₁	Larg. de denture h ₁	Ancho diente h ₁	h ₁ 15
Largh. dente L	Tooth width L	Zahnbreite L	Larg. de denture L	Ancho diente L	L 14,7
Largh. dente h ₂	Tooth width h ₂	Zahnbreite h ₂	Larg. de denture h ₂	Ancho diente h ₂	h ₂ 44,0
Largh. dente h ₃	Tooth width h ₃	Zahnbreite h ₃	Larg. de denture h ₃	Ancho diente h ₃	h ₃ 73,3
Altezza totale H	Full height H	Gesamt Höhe H	Hauteur totale H	Altura total H	H -

Corone tornite sui lati, dentate con creatore
Plate Wheels turned on both sides and
toothed by milling cutter
Seitlich plan gedrehte, wälzgefräste
Zahnkränze
Disques tournés sur les flancs, dentés à la
fraise
Coronas torneadas en los lados, dientes
obtenidos con fresa madre

Z	D _e	D _p	CS		CD		CT	
			cod.	D	cod.	D	cod.	D
10	95,32	82,19	CS 12A10	15				
11	103,28	90,14	CS 12A11	15				
12	111,26	98,14	CS 12A12	15				
13	119,26	106,12	CS 12A13	15				
14	127,27	114,15	CS 12A14	15				
15	135,29	122,17	CS 12A15	15				
16	143,32	130,20	CS 12A16	20				
17	151,35	138,22	CS 12A17	20				
18	159,39	146,28	CS 12A18	20				
19	167,44	154,33	CS 12A19	20				
20	175,49	162,38	CS 12A20	20				
21	183,54	170,43	CS 12A21	20				
22	191,60	178,48	CS 12A22	20				
23	199,66	186,53	CS 12A23	20				
24	207,72	194,59	CS 12A24	20				
25	215,78	202,66	CS 12A25	20	CD 12A25	25	CT 12A25	30

Z	D _e	D _p	CS		CD		CT	
			cod.	D	cod.	D	cod.	D
26	223,84	210,72	CS 12A26	20				
27	231,91	218,79	CS 12A27	20				
28	239,98	226,85	CS 12A28	20				
30	256,12	243,00	CS 12A30	20	CD 12A30	25	CT 12A30	30
32	272,26	259,13	CS 12A32	25				
35	296,48	283,36	CS 12A35	25				
38	320,70	307,59	CS 12A38	25	CD 12A38	25	CT 12A38	30
45	377,24	364,12	CS 12A45	25	CD 12A45	25	CT 12A45	30
50	417,64	404,52	CS 12A50	25				
57	474,20	461,08	CS 12A57	25	CD 12A57	25	CT 12A57	40
76	627,80	614,64	CS 12A76	25	CD 12A76	25	CT 12A76	40

Corone per catene semplici, doppie e triple a rulli secondo: DIN 8188 - ISO/R 606 - ANSI B 29,1

Plate wheels for simplex, duplex and triplex chain to: DIN 8188 - ISO/R 606 - ANSI B 29,1

Kettenradscheiben mit einseitiger Nabe für Simplex- Duplex-Triplex-Rollenkette nach:

DIN 8188 - ISO/R 606 - ANSI B 29,1

Disques avec moyeu déporté pour chaînes simples, doubles et triples à rouleaux suivant les normes:

DIN 8188 - ISO/R 606 - ANSI B 29,1

Coronas para cadena simple, doble y triple de rodillos según: DIN 8188 - ISO/R 606 - ANSI B 29,1



1"1/4 x 3/4"

ASA 100 - 1-2-3 31,75 x 19,05 mm

CATENA:	CHAIN:	KETTE:	CHAÎNE:	CADENA:	ASA 100
Passo	Pitch	Teilung	Pas	Paso	31,75
Larghezza interna	Internal width	Innere Breite	Largeur interieure	Ancho interno	19,05
Rullo ø	Roller ø	Rollen ø	ø du rouleau	Rodillo ø	19,05

CORONE	PLATE WHEELS	KETTENRÄDSCHLEIBEN	DISQUES	CORONAS	ASA 100
Raggio dente r	Tooth radius r	Radius r	Rayon de denture r	Radio diente r	r 33,5
Larghezza raggio C	Radius width C	Breite C	Largeur de rayon C	Ancho radio C	C 4
Largh. dente h ₁	Tooth width h ₁	Zahnbreite h ₁	Larg. de denture h ₁	Ancho diente h ₁	h ₁ 18
Largh. dente L	Tooth width L	Zahnbreite L	Larg. de denture L	Ancho diente L	L 17,7
Largh. dente h ₂	Tooth width h ₂	Zahnbreite h ₂	Larg. de denture h ₂	Ancho diente h ₂	h ₂ 53,5
Largh. dente h ₃	Tooth width h ₃	Zahnbreite h ₃	Larg. de denture h ₃	Ancho diente h ₃	h ₃ 89,2
Altezza totale H	Full height H	Gesamt Höhe H	Hauteur totale H	Altura total H	H -

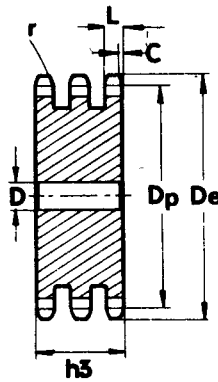
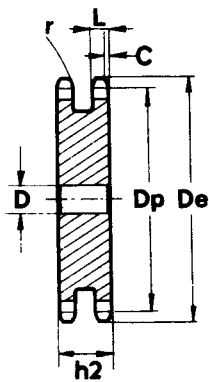
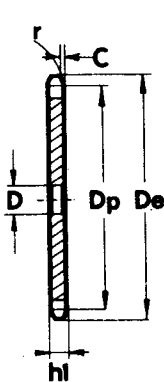

Corone tornite sui lati, dentate con creatore
 Plate Wheels turned on both sides and
 toothed by milling cutter
 Seitlich plan gedrehte, wälzgefräste
 Zahnkränze
 Disques tournés sur les flancs, dentés à la
 fraise
 Coronas torneadas en los lados, dientes
 obtenidos con fresa madre

Z	D _e	D _p	CS		CD	
			cod.	D	cod.	D
8	98,1	82,96	CS 15A08	16		
9	108,0	92,84	CS 15A09	16		
10	117,9	102,74	CS 15A10	16		
11	127,8	112,68	CS 15A11	16		
12	137,8	122,68	CS 15A12	20		
13	147,8	132,65	CS 15A13	20		
14	157,8	142,68	CS 15A14	20		
15	167,9	152,72	CS 15A15	20		
16	177,9	162,75	CS 15A16	25		
17	187,9	172,78	CS 15A17	25		
18	198,0	182,85	CS 15A18	25		
19	208,1	192,91	CS 15A19	25		
20	218,1	202,98	CS 15A20	25	CD 05A20	25
21	228,2	213,04	CS 15A21	25		
22	238,3	223,11	CS 15A22	25		
23	248,3	233,17	CS 15A23	25		
24	258,4	243,23	CS 15A24	25		
25	268,5	253,33	CS 15A25	25	CD 15A25	25

Z	D _e	D _p	CS		CD	
			cod.	D	cod.	D
26	278,6	263,40	CS 15A26	25		
27	288,6	273,40	CS 15A27	25		
28	298,7	283,56	CS 15A28	25		
29	308,8	293,65	CS 15A29	25		
30	318,9	303,75	CS 15A30	25	CD 15A30	25
31	329,0	313,85	CS 15A31	25		
32	339,1	323,91	CS 15A32	25		
33	349,2	334,01	CS 15A33	25		
34	359,3	344,10	CS 15A34	25		
35	369,4	354,20	CS 15A35	25		
36	379,5	364,30	CS 15A36	25		
37	389,5	374,39	CS 15A37	25		
38	399,6	384,49	CS 15A38	25	CD 15A38	30
39	409,7	394,59	CS 15A39	25		
40	419,8	404,68	CS 15A40	25		
45	470,3	455,17	CS 15A45	30	CD 05A45	30
57	591,5	576,36	CS 15A57	30	CD 05A57	30

CORONE / PLATE WHEELS / KETTENRADSCHIEBEN / DISQUES / CORONAS



Corone per catene semplici, doppie e triple a rulli secondo: DIN 8188 - ISO/R 606 - ANSI B 29,1

Plate wheels for simplex, duplex and triplex chain to: DIN 8188 - ISO/R 606 - ANSI B 29,1

Kettenradscheiben mit einseitiger Nabe für Simplex- Duplex-Triplex-Rollenkette nach:

DIN 8188 - ISO/R 606 - ANSI B 29,1

Disques avec moyeu déporté pour chaînes simples, doubles et triples à rouleaux suivant les normes:

DIN 8188 - ISO/R 606 - ANSI B 29,1

Coronas para cadena simple, doble y triple de rodillos según: DIN 8188 - ISO/R 606 - ANSI B 29,1

1"1/2 x 1"

ASA 120 - 1-2-3 38,1 x 25,4 mm

CATENA:	CHAIN:	KETTE:	CHAÎNE:	CADENA:	ASA 120
Passo	Pitch	Teilung	Pas	Paso	38,1
Larghezza interna	Internal width	Innere Breite	Largeur interieure	Ancho interno	25,4
Rullo ø	Roller ø	Rollen ø	ø du rouleau	Rodillo ø	22,22

CORONE	PLATE WHEELS	KETTENRÄDSCHIEBEN	DISQUES	CORONAS	ASA 120
Raggio dente r	Tooth radius r	Radius r	Rayon de denture r	Radio diente r	r 40,5
Larghezza raggio C	Radius width C	Breite C	Largeur de rayon C	Ancho radio C	C 4,8
Largh. dente h ₁	Tooth width h ₁	Zahnbreite h ₁	Larg. de denture h ₁	Ancho diente h ₁	h ₁ 24,1
Largh. dente L	Tooth width L	Zahnbreite L	Larg. de denture L	Ancho diente L	L 23,6
Largh. dente h ₂	Tooth width h ₂	Zahnbreite h ₂	Larg. de denture h ₂	Ancho diente h ₂	h ₂ 69
Largh. dente h ₃	Tooth width h ₃	Zahnbreite h ₃	Larg. de denture h ₃	Ancho diente h ₃	h ₃ 114,5
Altezza totale H	Full height H	Gesamt Höhe H	Hauteur totale H	Altura total H	H -

Z	D _e	D _p	CS		CD	
			cod.	D	cod.	D
16	214,77	195,29	CS 14A16	25	CD 14A17	25
17	226,83	207,35	CS 14A17	25	CD 14A18	25
18	238,89	219,41	CS 14A18	25	CD 14A18	25
20	263,03	243,55	CS 14A20	25	CD 14A20	25
22	287,20	267,72	CS 14A22	25		
25	323,47	303,99	CS 14A25	25	CD 14A25	25
30	383,97	364,49	CS 14A30	25	CD 14A30	30
32	408,19	388,71	CS 14A32	30		
38	480,85	461,37	CS 14A38	30	CD 14A38	30
45	565,67	546,19	CS 14A45	30	CD 14A45	40
57	711,10	691,62	CS 14A57	30	CD 14A57	40

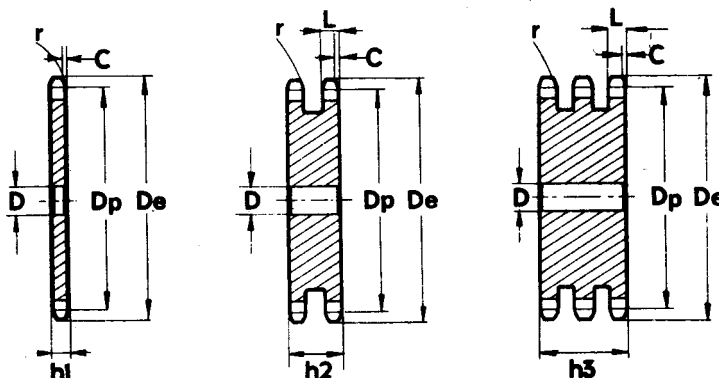

1"3/4 x 1"1/4

ASA 140 - 1-2-3 44,45 x 25,4 mm

CATENA:	CHAIN:	KETTE:	CHAÎNE:	CADENA:	ASA 140
Passo	Pitch	Teilung	Pas	Paso	44,45
Larghezza interna	Internal width	Innere Breite	Largeur interieure	Ancho interno	25,4
Rullo ø	Roller ø	Rollen ø	ø du rouleau	Rodillo ø	25,4

CORONE	PLATE WHEELS	KETTENRÄDSCHIEBEN	DISQUES	CORONAS	ASA 140
Raggio dente r	Tooth radius r	Radius r	Rayon de denture r	Radio diente r	r 47,5
Larghezza raggio C	Radius width C	Breite C	Largeur de rayon C	Ancho radio C	C 5,8
Largh. dente h ₁	Tooth width h ₁	Zahnbreite h ₁	Larg. de denture h ₁	Ancho diente h ₁	h ₁ 24,1
Largh. dente L	Tooth width L	Zahnbreite L	Larg. de denture L	Ancho diente L	L 23,6
Largh. dente h ₂	Tooth width h ₂	Zahnbreite h ₂	Larg. de denture h ₂	Ancho diente h ₂	h ₂ 72,5
Largh. dente h ₃	Tooth width h ₃	Zahnbreite h ₃	Larg. de denture h ₃	Ancho diente h ₃	h ₃ 121,3
Altezza totale H	Full height H	Gesamt Höhe H	Hauteur totale H	Altura total H	H -

2" x 1"1/4

ASA 160 - 1-2-3 50,8 x 31,75 mm

CATENA:	CHAIN:	KETTE:	CHAÎNE:	CADENA:	ASA 160
Passo	Pitch	Teilung	Pas	Paso	50,8
Larghezza interna	Internal width	Innere Breite	Largeur interieure	Ancho interno	31,75
Rullo ø	Roller ø	Rollen ø	ø du rouleau	Rodillo ø	28,58

CORONE	PLATE WHEELS	KETTENRÄDSCHIEBEN	DISQUES	CORONAS	ASA 160
Raggio dente r	Tooth radius r	Radius r	Rayon de denture r	Radio diente r	r 54
Larghezza raggio C	Radius width C	Breite C	Largeur de rayon C	Ancho radio C	C 7
Largh. dente h ₁	Tooth width h ₁	Zahnbreite h ₁	Larg. de denture h ₁	Ancho diente h ₁	h ₁ 30,1
Largh. dente L	Tooth width L	Zahnbreite L	Larg. de denture L	Ancho diente L	L 29,5
Largh. dente h ₂	Tooth width h ₂	Zahnbreite h ₂	Larg. de denture h ₂	Ancho diente h ₂	h ₂ 88
Largh. dente h ₃	Tooth width h ₃	Zahnbreite h ₃	Larg. de denture h ₃	Ancho diente h ₃	h ₃ 146,6
Altezza totale H	Full height H	Gesamt Höhe H	Hauteur totale H	Altura total H	H -

Corone tornite sui lati, dentate con creatore
Plate Wheels turned on both sides and
toothed by milling cutter
Seitlich plan gedrehte, wälzgefärdete
Zahnkränze
Disques tournés sur les flancs, dentés à la
fraise
Coronas torneadas en los lados, dientes
obtenidos con fresa madre